

Fixed height with horizontal outlet - Square top

Product information for the product group

ACO Product benefits

- Fully inspectable and cleanable
- Fully removable and easily cleanable stainless steel foul air trap (FAT)
- Full drainability
- Internal radii equal or larger than 3 mm
- Fully welded hygienic joints
- Steel thickness min. 1,5 mm
- Edge infill
- ACO protective cover available
- Fully pickled and passivated

- BIM models are available in ACO Building Drainage BIM Revit libraries
- Hygienic design following EN 1672, EN ISO 14159 and EHEDG document 8, 13 and 44
- Certified according to EN 1253-1
- Available in 1.4301 (304) or 1.4404 (316L) grades of stainless steel
- Outlet diameter 75 or 110 mm
- Gully top size 200 x 200 mm or 250 x 250 mm
- Adjustable EasyFix levelling feet
- Wide range of gratings for load class L 15, R 50, M 125 or N 250 (EN 1253-1) including slip resistant solution
- Silt basket available as accessory

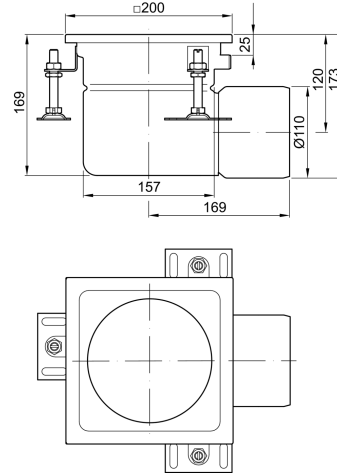









Item Technical Data 408011



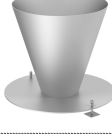
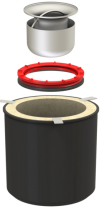
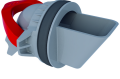

Gully top dimensions [mm]	Outlet diameter \varnothing [mm]	Odour trap	Flow rate EN 1253-1 / Direct * [l/s]	Material
200 x 200	110	With	5	1.4301

Standard edge

Accessories

	Description	Used with	Weight [kg]	Item number	
	ACO Easy FAT Replacement sealing ring: Optional compatible silt baskets:	<input checked="" type="checkbox"/> ACO gully 157, fixed height	0.89		
	<input checked="" type="checkbox"/> 416906 (1.4301) <input checked="" type="checkbox"/> 416907 (1.4404)				
	BenefitsUser-friendly installation and maintenance; Complete ease in removing and cleaning; Minimum steel thickness of 1.2 mm; Fully pickled and passivated; Extensively tested and classified in accordance with EN 1253-1 guidelines-FeaturesMaximum flow rate with horizontal gully: 2.6 l/s; Maximum flow rate with vertical gully: 2.6 l/s; Material: 1.4301; Silt basket not included				449681
	BenefitsUser-friendly installation and maintenance; Complete ease in removing and cleaning; Minimum steel thickness of 1.2 mm; Fully pickled and passivated; Extensively tested and classified in accordance with EN 1253-1 guidelines-FeaturesMaximum flow rate with horizontal gully: 2.6 l/s; Maximum flow rate with vertical gully: 2.6 l/s; Material: 1.4404; Silt basket not included				449683
	ACO Easy FAT Replacement sealing ring:	<input checked="" type="checkbox"/> ACO gully 157, fixed height	1.09		
	BenefitsUser-friendly installation and maintenance; Complete ease in removing and cleaning; Minimum steel thickness of 1.2 mm; Fully pickled and passivated; Extensively tested and classified in accordance with EN 1253-1 guidelines-FeaturesMaximum flow rate with horizontal gully: 2.4 l/s; Maximum flow rate with vertical gully: 2.4 l/s; Material: 1.4301; Silt basket included				449682
	BenefitsUser-friendly installation and maintenance; Complete ease in removing and cleaning; Minimum steel thickness of 1.2 mm; Fully pickled and passivated; Extensively tested and classified in accordance with EN 1253-1 guidelines-FeaturesMaximum flow rate with horizontal gully: 2.4 l/s; Maximum flow rate with vertical gully: 2.4 l/s; Material: 1.4404; Silt basket included				449684
	Silt basket <input checked="" type="checkbox"/> Stainless steel <input checked="" type="checkbox"/> 0,6 litre capacity	<input checked="" type="checkbox"/> ACO gully 157 - vertical <input type="checkbox"/> Fixed height or telescopic <input checked="" type="checkbox"/> ACO hygienic box channel <input type="checkbox"/> Channel dimension <input type="checkbox"/> Width Wo [mm]: 300, 400, 500, 600, 800 <input type="checkbox"/> Outlet øD [mm]: 142 or welded with ACO hygienic gully 157 <input type="checkbox"/> Direction of gully outlet: vertical			
	Material grade 1.4301 (304)			416904	

	Description	Used with	Weight [kg]	Item number
	Material grade 1.4404 (316L)			416905
	Silt basket ■ Stainless steel ■ 0,3 litre capacity	■ ACO gully 142 and 157 - horizontal <input type="checkbox"/> Fixed height or Telescopic ■ ACO hygienic box channel <input type="checkbox"/> Channel dimension <input type="checkbox"/> Width Wo [mm]: 300, 400, 500, 600, 800 <input type="checkbox"/> Outlet øD [mm]: 142 or welded with ACO hygienic gully 157 <input type="checkbox"/> Direction of gully outlet: horizontal		
	Material grade 1.4301 (304)			416906
	Material grade 1.4404 (316L)			416907
	ACO tundish ■ Stainless steel ■ Material grade 1.4301 (304)	■ ACO gully top size 200 x 200 mm		415918
	ACO tundish ■ Stainless steel ■ Material grade 1.4301 (304)	■ ACO gully top size 250 x 250 mm		413546
	ACO tundish portable ■ Stainless steel ■ Material grade 1.4301 (304)	■ ACO drainage independent of visible edge dimensions		415821
	■ Fixed height, vertical ■ Telescopic, vertical ■ Made from 1.4404 (316) grade of stainless steel ■ NBR	■ ACO hygienic gully 157 <input type="checkbox"/> Fixed height, vertical <input type="checkbox"/> Telescopic, vertical		416932
	ACO fire resistant kit for gully 157/ DN 110			416933
	■ Plastic	■ ACO gully 157 <input type="checkbox"/> Outlet DN 100 <input type="checkbox"/> Horizontal		445845
	Odour trap Stainless steel ■ Height 50 mm	■ ACO hygienic gully 157 <input type="checkbox"/> Telescopic		
	Material grade 1.4301 (304)			408200

	Description	Used with	Weight	Item number
			[kg]	
 	Material grade 1.4404 (316L)			408210
	Standard foul air trap support NBR	<ul style="list-style-type: none"> ■ ACO hygienic gully 157 □ Fixed height □ Telescopic 		408201
	Friction ring SBR	<ul style="list-style-type: none"> ■ ACO hygienic gully 157 □ Telescopic 		408205

You can find further accessories under → <https://www.buildingdrainage.aco/search/?q=408011>