

# AQUALINE

## AQAV170110ES

### Product Description

The Aqualine Avon 170mm End Side  $\varnothing$ 110mm Outlet is designed to be hardwearing and hygienic and provides an ideal solution for environments that require high standards of cleanliness.

This outlet is designed with low invert levels, allowing it to be positioned along the channel length and easily connect to underground drainage. Featuring a removable waste basket, as well as rodding access for easy cleaning.

This product is available in a range of sizes to accommodate a variety of flow rates.

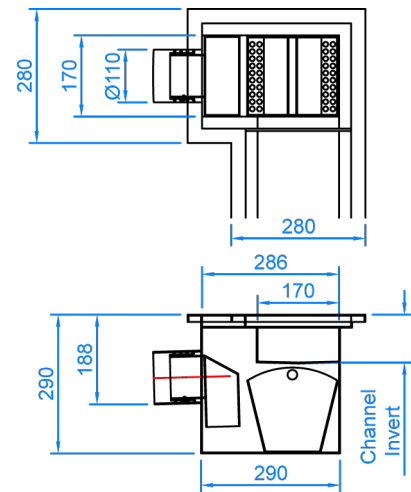

Avon Outlet 170mm End Side  $\varnothing$ 110mm Outlet  
Scale -1:8

### Key Benefits

- Manufactured in England
- Available in a variety of sizes and styles
- In-house bespoke design service
- Designed to be durable and easy to clean
- Ideal for food grade environments
- Easy installation
- Welded & polished joints
- Suitable for all types of factory traffic
- Load Class up to FACTA D400 (outlet cover dependant)
- Fitting and installation service available
- Maintenance & inspection contracts available

### Technical Specification

- Grade 304 stainless steel (British Standard 304S31, Euronorm 1.4301).
- 1 x stainless steel removable waste basket.
- 50mm water trap.
- Variable filtration mesh hole size.

## Drainage Systems

The Aqualine range keeps things flowing with hygienic, durable and low maintenance drainage solutions, suitable for use in food-grade environments.

Made from high quality stainless steel in our state-of-the-art facility, all Aqualine products are designed by our in-house engineers and manufactured in the UK.

In addition to a wide range of off the shelf options, we offer a bespoke design service, enabling us to customise and create products to meet any customer requirements.

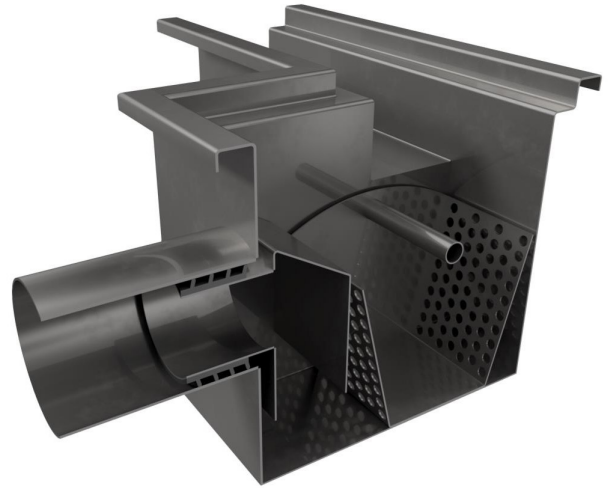

## Maintenance

Stainless steel equipment should be routinely checked for concentrated fluid build up, retained deposits and damage as these can lead to corrosion. If required, we are able to provide planned preventative maintenance programmes and inspections to ensure that drainage systems are in optimal operating condition.

## Cleaning

All of our Aqualine range is designed to be easy to clean and maintain. The recommended cleaning methods include; steam, water, non-abrasive scrubbing, organic solvents and mild detergents. The frequency and specific cleaning method used will depend on the application of the drainage. All products should be routinely checked for damage.

## Installation

Our dedicated installation team are capable of undertaking projects of any scale with assistance and expertise provided at every stage of the project. All installations adhere to our industry leading service standards, are handed over ready to use and include a high quality finish with welded and polished joints and commissioning included. Installation services are available on all product ranges and bespoke products.

## Additional options

We offer a bespoke design service for our drainage systems to meet the requirements of your workplace or project.

To discuss a project, or bespoke design requirement, contact our technical sales department.

01509611235  
www.alwayaqualine.co.uk  
enquiries@alwayaqualine.co.uk

